

CV3Fm6

ULTRASONIC WIND-VANE

CV3F is a new generation wind measurement sensor providing, on a standardised series electric line, the values from the wind module in knots or metres per second, relative wind direction and its temperature in degrees C.

The sensor can be used directly with a PC type computer or read by modern repeaters with a standard NMEA 183 input.

Operating principle :

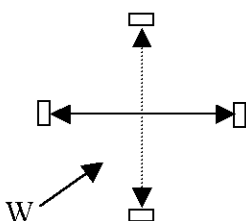

Sound, ultrasound, is carried by the movement of the fluid through which it passes.

Four electro-acoustic transducers communicate in twos using ultra-sound signals to determine, in two orthogonal axes, the differences in transit times of the waves, induced by the air flow. The measurements are used in an integrated computer to establish the wind module and its direction relative to a reference axis.

The measurement of temperature serves to refine the calibration.

The method provides a sensitivity of 0.5 knots, a range of up to 100 knots and excellent linearity.

Equipment supplied :

- CV3F sensor head and 300mm support
- 2 stainless steel brackets
- 25 m coaxial cable fitted with a connector
- Box for link to supply and reader display
- Installation instructions

Electrical characteristics :

- Digital output signals:
 - NMEA 183, MWV: 5 digits for the module, 4 digits for the direction, 1 digit for validity state.
 - NMEA 183, XDR: 4 digits for the temperature.
- BARO Option
 - NMEA 183, MDA: 4 digits for the pressure, 4 digits for the temperature.
 - NMEA 183, XDR: 4 digits for the temperature, 4 digits for the atmospheric pressure.
- Wind module resolution: 0.1 knots
- Wind module dynamics: 0.5 to 99.5 knots
- Resolution: 1 degree
- Sensitivity to direction: + / 1.5 degrees
- Supply: 10 to 14 V DC
- Consumption: 25 milliamperes
- Operating temperature: -10°C (without ice) to +50°C

LCJ CAPTEURS – Z.A. Le Chêne Ferré – 44120 VERTOU – France

Tel /Fax : +33 (0)2 40 05 08 55 - Email : lcjcapteurs@lcjcapteurs.com - Web : <http://www.lcjcapteurs.com/>

Mechanical characteristics :

Dimensions in mm

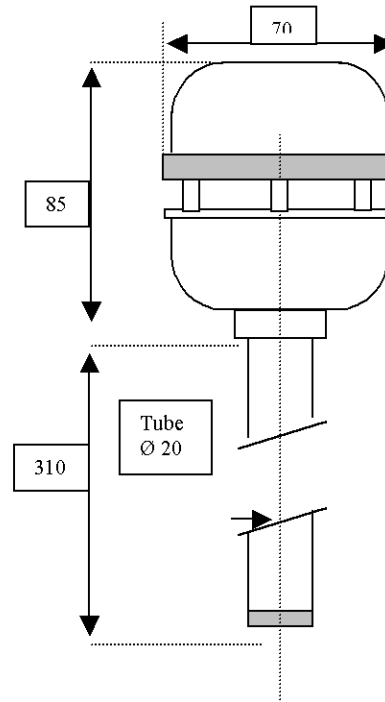

Installation :

Find a place free from obstructions to the wind.

The CV3F sensor can be fitted using the two stainless steel brackets to the side or top of the mast as shown.

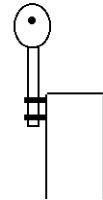

Set up the alignment mark parallel to the axis of the vessel pointing towards the bow or, when it is a land installation towards a reference direction, as a rule, true north. Better precision is obtained by taking the struts linking the two halves of the sensor as an axis for the alignment.

Join the coaxial cable to the sensor as in the diagram below and lead the cable to the site for the display unit.

Avoid as far as possible closeness to cables which might induce high levels of radio-electrical interference.

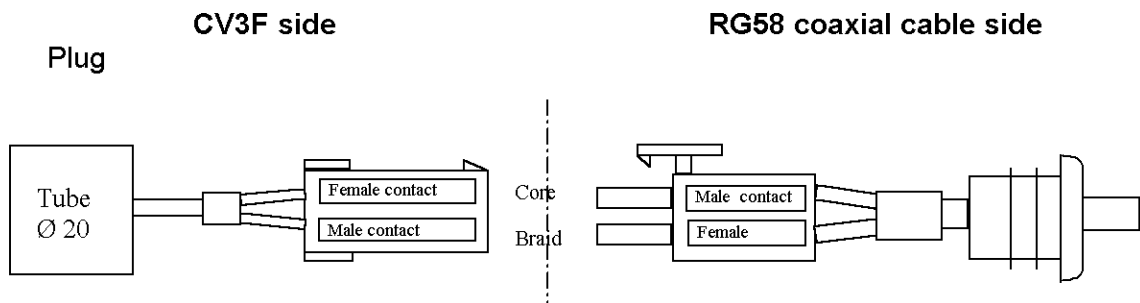

The plug at the end of the tube has a hole to allow the passage of coaxial cable RG58 and a small hole (1.5mm), sufficient to assure a natural weatherproofing and at the same time to stabilize the internal and external pressures on CV3F. During installation care must be taken to ensure that this hole is not closed, and to be left in the same atmospheric pressure as the sensor itself.

Interconnections

Connect the 12VDC (10 to 14V) supply. Blue - / Brown +

Connect the coaxial cable of the CV3F sensor correctly connecting the core and screening.

Connect the display receiver equipment to the NMEA connector:

- for the COM(1) port of an RS232 computer

connect b1 to Rx terminal 2 of COM1

connect b3 to 0V terminal 5 of COM1

if necessary, connect terminals 6 and 7 of COM1 together.

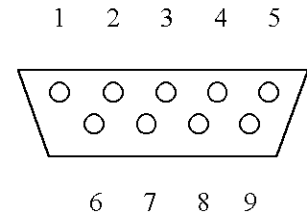

PC SUBD 9
terminal COM1
type connector -
Soldering side

- for a floating RS422 standardised NMEA 183 input

Make sure in advance that none of the receiver inputs is connected to 0 Volts, otherwise use the RS232 type connection.

connect b1 to +Ve (or In +) or A of the NMEA display

connect b2 to -Ve (or In -) or B of the NMEA display

The b1 b2 output supplies a differential voltage greater than 2 Volts at a load of 4 mA which allows two receivers to be controlled simultaneously.

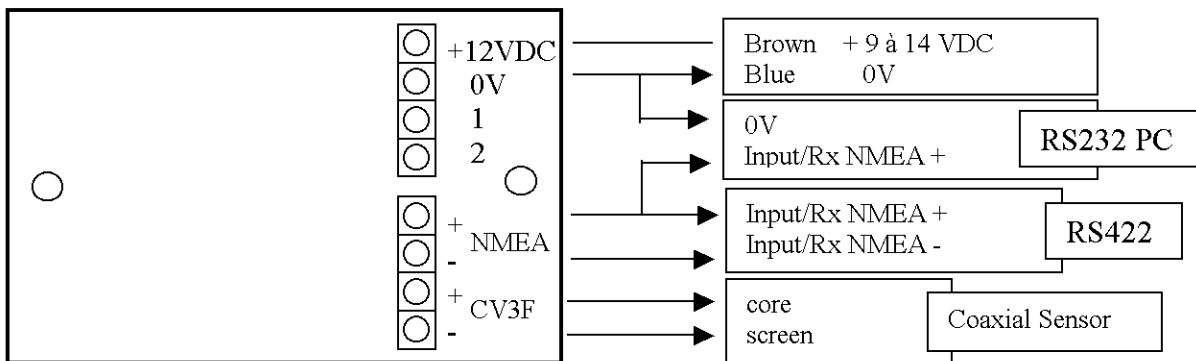

L=87mm l=58mm H=25 mm

Output messages

Example:

\$IIMWV,226.0,R,000.00,N,A*0B

\$WIXDR,C,036.5,C,,*52

\$PLCJ,67FF,6EFF,28,,,,,5050,5050

\$PLCJEA870,6D98,C500,0056,AC,

CV3F - BARO option

Measurement units: Bar
 Resolution: 0.001 Bar
 Measurement range: 0.900 to 1.100 Bar
 Temperature range: 0 to 40°C

The barometric sensor is fitted with a pipe allowing connection of a Ø 4mm hose.

Connect the 12V (10 to 14VDC) supply. Blue - / Brown +

Connect the coaxial cable of the CV3F sensor correctly connecting the core and screening.

Connect the display receiver equipment to the NMEA connector:

- for the COM(1) port of an RS232 computer

connect Rx terminal 2 of COM1
 to the AUX connector block terminal A
 connect 0V terminal 5 of COM1
 to the ALIM (SUPPLY) connector block terminal 0V

if necessary, connect terminals 6 and 7 of COM1 together.

- for a floating RS422 standardised NMEA 183 input

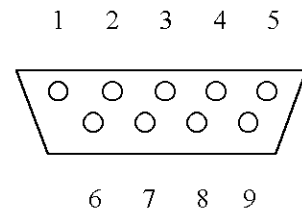

PC SUBD 9 terminal
 COM1 type connector -
 Soldering side

Make sure in advance that none of the receiver inputs is attached to 0 Volts, otherwise use the RS232 type connection.

connect terminal A of the AUX connector block to +Ve (or In +) or A of the NMEA display
 connect terminal B of the AUX connector block to -Ve (or In -) or B of the NMEA display



- 12 V Brow
- 0 V Blue
- CV3F Core
- Screening
- OUT + NMEA
- OUT - NMEA
- Not used
- 0 V

L=131mm W=58mm H=37mm

Output messages

Example

\$IIMVV,315.0,R,009.40,N,A \$PLCJ,75FA,7DEA,03,,,6D7C,837E
 \$WIXDR,C,022.5,C,,P,0.996,B \$WIMDA,,I,0.996,B,022.5,C